

Max allowed angle from horizontal plane for proper trackball functionality

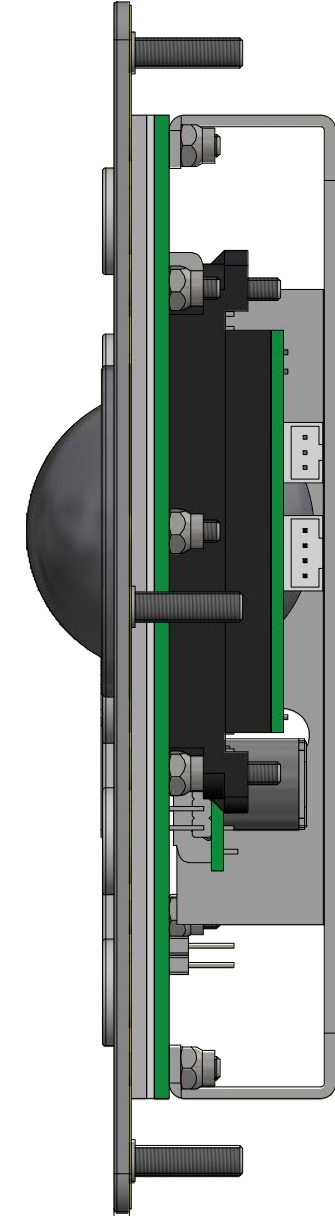

2,00 (front plate)

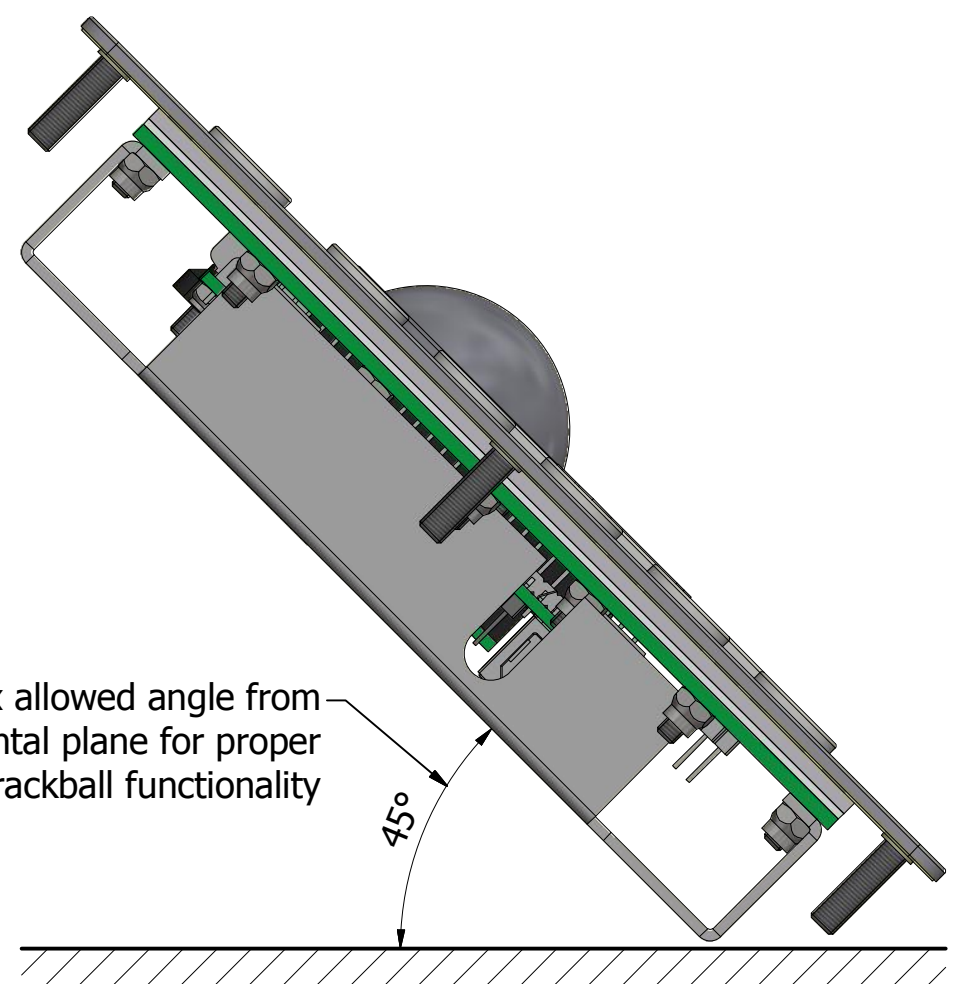
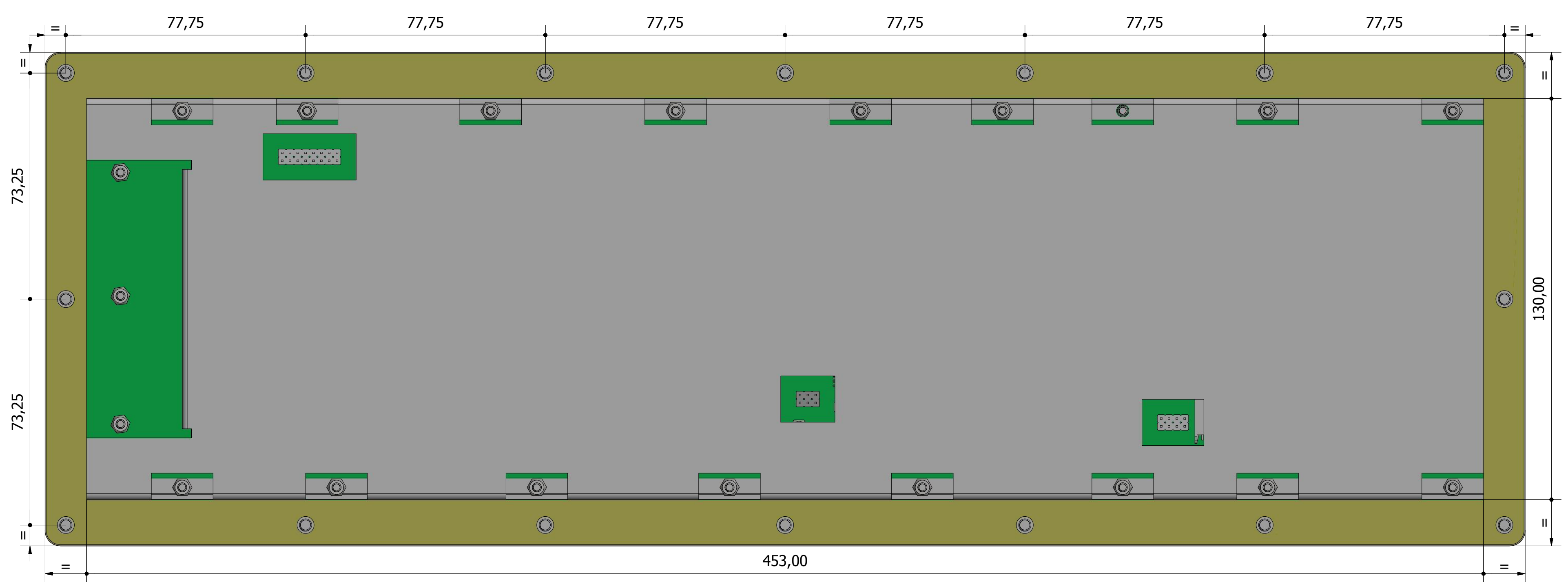
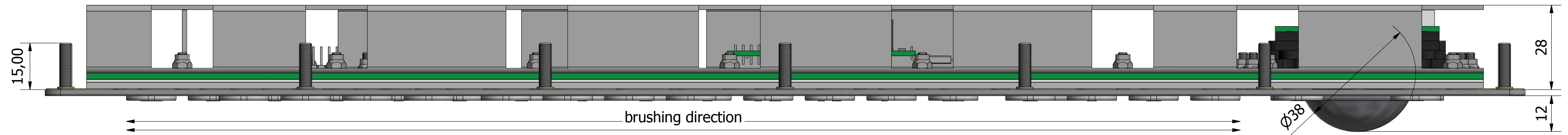
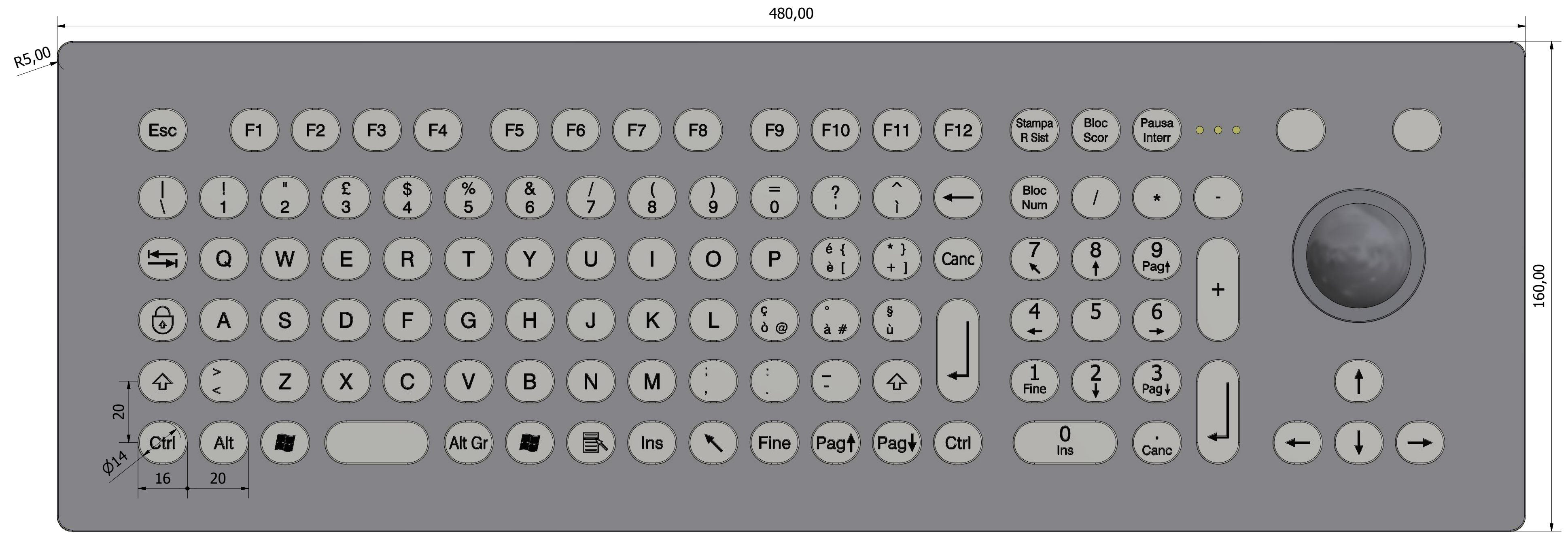

**Grafos Steel S.r.l.**  
 Via Treves 19/21  
 41043 Formigine (MO) ITALY  
 Tel. +39.059.57.50.267  
 www.grafossteel.it

Title: Fit Inox keyboard; 105 buttons (E16 keycap); front mount; USB and PS/2 interface; stainless steel trackball  
 P/N: FIT.105E16.F-TI  
 Rev: FIT.105E16.F-TI (data-sheet).idw  
 Drawn: A.Tosi  
 Date: 06/07/2015  
 ISO 2768 F  
 Approved:

Tolerance class	Length (mm)		
	>0 - 6	>6-30	>30-120
C (Coarse)	±0.2	±0.5	±1.2
M (medium)	±0.1	±0.2	±0.5
F (Fine)	±0.05	±0.1	±0.15

Material: - Surface treatment: -  
 Sheet: 1 Of: 2

UNLESS OTHERWISE SPECIFIED, DIMENSIONS ARE IN MILLIMETERS



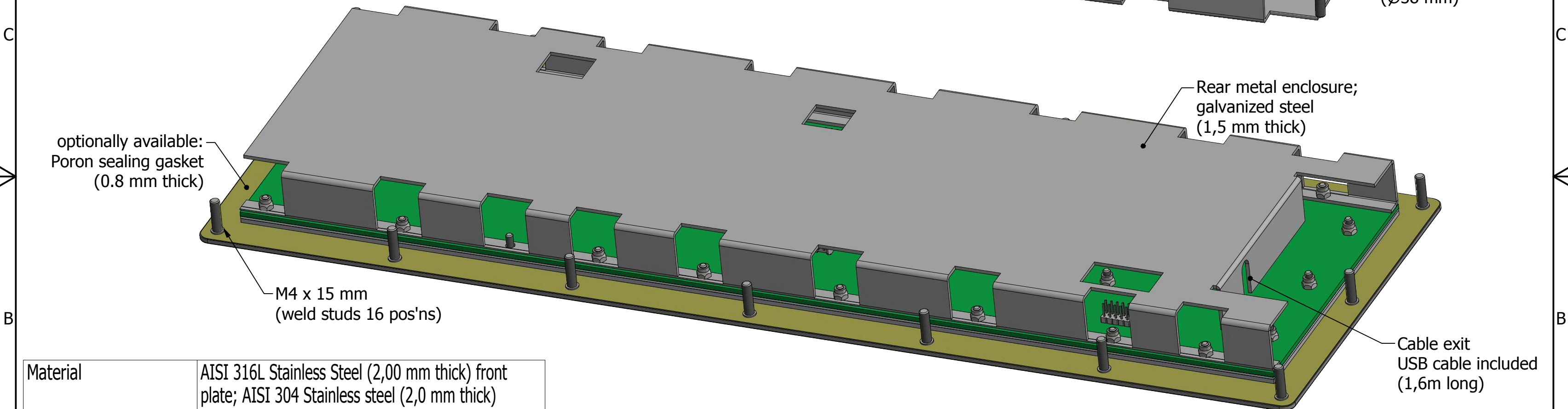
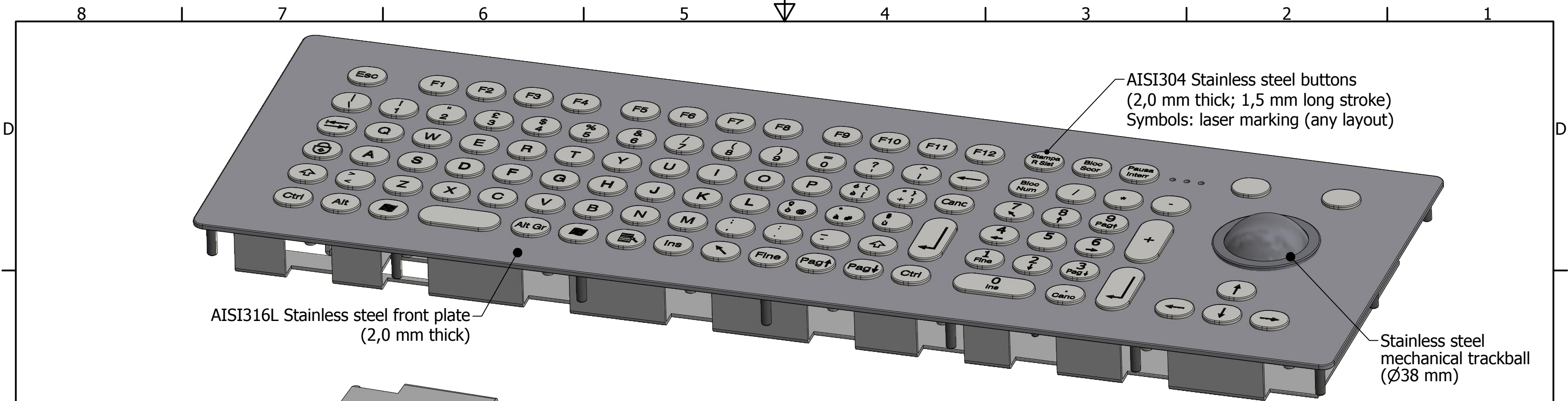

Material	AISI 316L Stainless Steel (2,00 mm thick) front plate; AISI 304 Stainless steel (2,0 mm thick) buttons with built-in silicone rubber sealing gasket
Lettering	Laser marking (any layout)
Button stroke	1,5 mm +/- 0,1 mm
Actuation force	1,5 N (typical)
Life expectancy	>2.000.000 cycles
IP Protection rate	IP65 (when ball is stationary); IP54 (when ball is rotating)
Impact Protection Rate	IK08
Contact technology	Conductive carbon pill on Gold plated PCB
Connection	USB
Operating temperature	0°/+50°C
Storage temperature	-25°/+55°C

<b>Grafos Steel S.r.l.</b> Via Treves 19/21 41043 Formigine (MO) ITALY Tel. +39.059.57.50.267 www.grafossteel.it		Title: Fit Inox keyboard; 105 buttons (E16 keycap); front mount; USB and PS/2 interface; stainless steel trackball																	
Date: 06/07/2015		P/N: FIT.105E16.F-TI																	
Material: -		Rev: File: FIT.105E16.F-TI (data-sheet).idw																	
Surface treatment: -		Tolerance class																	
UNLESS OTHERWISE SPECIFIED, DIMENSIONS ARE IN MILLIMETERS		Dimensions without indicated tolerances - precision according to:																	
		ISO 2768 F																	
		Length (mm)																	
		<table border="1"> <tr> <td>&gt;0 - 6</td> <td>&gt;6-30</td> <td>&gt;30-120</td> <td>&gt;120-400</td> </tr> <tr> <td>±0.2</td> <td>±0.5</td> <td>±0.8</td> <td>±1.2</td> </tr> <tr> <td>±0.1</td> <td>±0.2</td> <td>±0.3</td> <td>±0.5</td> </tr> <tr> <td>±0.05</td> <td>±0.1</td> <td>±0.15</td> <td>±0.2</td> </tr> </table>		>0 - 6	>6-30	>30-120	>120-400	±0.2	±0.5	±0.8	±1.2	±0.1	±0.2	±0.3	±0.5	±0.05	±0.1	±0.15	±0.2
>0 - 6	>6-30	>30-120	>120-400																
±0.2	±0.5	±0.8	±1.2																
±0.1	±0.2	±0.3	±0.5																
±0.05	±0.1	±0.15	±0.2																
		Drawn: <b>A.Tosi</b> Approved: Sheet: 2 Of: 2																	